

# HITACHI SUBMERSIBLE MOTORS

**F 1**

Date: 09/01/17  
Supersedes: 03/22/16

## SAFETY PRECAUTIONS

For the best results with submersible motors, read this manual and all of the warning signs attached to the motor carefully before installing, operating, maintaining, testing and follow the instructions exactly.

In this manual, the rank of cautions is distinguished as **WARNING** and **CAUTION**.

 **WARNING** Indicates a potentially hazardous situation may happen, which, if not avoided, can result in death or serious injury.

 **CAUTION** Indicates a potentially hazardous situation may happen, which, if not avoided, can result in injury or damage of product.

Note that even a  **CAUTION** level situation may lead to a serious consequence according to circumstances. Be sure to follow every instruction, which contains important safety information. Also focus on and observe the items and instructions described under “Notes” in the text.

After reading these documents, be sure to store them in a place where those using the device can refer to them easily.

## HANDLING AND INSTALLATION

 **WARNING** This motor is intended for installation by technically qualified personnel.

 **WARNING** Always be sure to use the product’s voltage and frequency indicated on the nameplate. Using at a voltage or frequency other than the values indicated on the nameplate can cause motor burnout or fire.

 **WARNING** All electrical work should be performed by experienced, authorized personnel.

 **WARNING** Do not energize, or contact while energized, a motor that has indicated a short circuit.

 **WARNING** Serious or deadly electrical shock may result from incorrect connecting, control enclosures, metal plumbing, and all other metal near the motor or cable. The wire for power supply and grounding should be appropriately sized for the application and product.

 **WARNING** Do not work with energized power lines. Be sure to turn the power off before performing work. Failure to do so could cause electric shocks.

 **WARNING** This motor is not designed for use in applications where it will be in direct contact with liquids or gases under hazardous conditions.

 **WARNING**

Be sure to follow the specifications of the motor in terms of the fluid properties and fluid temperature.

Using outside of the specifications can result in motor damage, functional inhibition, electric shock, or fire.

 **WARNING**

The supply voltage, frequency, and number of phases must match all equipment requirements. Incorrect supply voltage, frequency, and number of phases can cause motor burnout or fire, damage of motor or control device, and voids the warranty.

 **WARNING**

Do not use the lead wires to pull, lift, carry or hang motor. The damaged lead wires can cause shock, burns or death.

 **WARNING**

Verify motor is filled with clean water before installing. The warranty is void if this is not done.

 **CAUTION**

This motor and lead assembly are designed only for use submerged in water.

 **CAUTION**

All three-phase control devices that are for submersible motors must provide Class 10, quick-trip, overload protection.

- 1) Do not use lead wires to pull, lift or handle the motor. The lead wires should be protected during storage, handling, moving and installation of the motor.
- 2) Inspect the motor to determine that it is the correct HP, voltage and size for the job and that there is no shipping damage.
- 3) The factory-installed water in the motor is supplied with Propylene Glycol capable of temperatures to -30°C(-22°F). Do not install, transport or store below these temperatures. If storage is necessary below these temperatures, drain the water from the motor.
- 4) After long periods of idleness and on all new installations, check the electrical resistance and megger the motor with lead wires connected: see table A. Prior to installation, the motor should have an insulation value of at least 50 megohms. After installation, motor and power cable should have a minimum insulation value of 1 megohm. If minimum values are not obtained, contact factory.
- 5) Check the tightness of drain plugs, mounting bolts and cable connections.
- 6) Do not hammer the shaft, coupling or slinger since this may damage the thrust bearing. Check the rotation of the shaft by hand to insure that it turns freely.
- 7) Do not drop the bottom end of the motor in the dirt or mud since this may plug up the diaphragm opening.
- 8) If motor is to be installed in a horizontal position, make sure that the lead wires are at the 12 o'clock position when facing the motor shaft (in horizontal position).

## TROUBLE SHOOTING OF SUBMERSIBLE MOTORS

- 1) Motor does not start.
  - No power supply. → Check for loose or corroded connections and motor lead terminals.
  - Defective connections. → Correct connections.
- 2) Fuses or relay blow when motor starts.
  - Incorrect voltage. → Apply correct voltage (Nameplate).
  - Incorrect fuses or relay. → Replace with proper fuses and relay.
  - Defective capacitors. → Replace with proper capacitors.
  - Wrong connections. → Correct wrong connections or short circuit.
  - Locked rotor conditions. → Correct pump or well conditions.
  - Insulation resistance down. → Check the line and correct.
- 3) Motor runs for a while and then blown fuses or relay.
  - Low voltage or high voltage. → Apply rated voltage.
  - Defective capacitors. → Replace with proper capacitors.
  - Different control box for the motor. → Replace with proper control box.
  - Defective starting voltage relay. → Replace with proper relay.
  - Pump is sand clogged. → Pull pump and clean well.
  - Overheated protector. → Shield the control box from heat source.

The following conditions are stated to provide the owner with a list of criteria for maximum motor life and to assure motor warranty.

## PRE-INSTALLATION

- 1) Maximum water temperature:
  - A) 35°C (95°F): 6" (5~40HP) motors.
  - B) 25°C (77°F): 6" (50,60HP), 8", 10", 12" and 14" motors.
- 2) PH content of the water between: 6.5 -8
- 3) Maximum chlorine content: 500 PPM  
Maximum Sulfuric acid iron content: 15 PPM  
Maximum Fluorine content: 0.8 PPM  
Maximum Electric conductivity: 118 µMHO/INCH
- 4) Maximum sand content: 50 PPM
- 5) Proper approved three-phase overload protection. See TABLE B.
- 6) Proper fusing for motor circuit protection. See TABLE C.
- 7) Proper line voltage variation during running conditions:  
60Hz: 460V, 230V ±10% , 50Hz: 380V ±10%  
at motor lead terminal.  
(voltage drop of cable should be considered by user.)  
Combination of voltage and frequency variation: ±10%  
(sum of absolute values of voltage and frequency)  
Current unbalance between legs should not exceed 5% of the average.
- 8) Proper sizing of motor HP. (current, thrust, voltage, etc.)
- 9) Motor must be set with minimum 10 feet clearance from the bottom of the well.
- 10) In the case of horizontal installation, the motor is to be rigidly aligned with the pump and firmly mounted to prevent any load on the shaft and bearings and to avoid any damaging vibrations to the motor.
- 11) The motor must always be immersed in water so that a flow velocity of cooling water at a rate of 0.5 feet per second flows past any and all parts of the motor. The motor will not operate in mud or sand.
- 12) Hitachi motor leads are sized for operation while submerged in water at the maximum rated ambient water temperature. The factory motor leads must be fully submerged at all times during operation to avoid damage or failure.
- 13) The power cables shall be sized large enough so that at rated current there will be less than a 5% voltage drop. See TABLE C. Cables must be waterproof submersible type.
- 14) For three-phase motors a balanced and properly sized transformer bank shall be provided. Improper electrical supply (for example, phase converter, V-connection transformer, etc.) or connections will void the warranty.
- 15) Single-phase protection is recommended for protection of the installation. Any failure due to single phasing of the incoming

voltage causing the motor to fail will void the warranty.

- 16) Surge suppressors are recommended in the interest of protecting the control panel, as well as the insulation system of the motor. Any motor failure due to lightning or other natural disasters will void the warranty.
- 17) Provide waterproof insulation splices between all lead wires and well cables.
- 18) In the event that a reduced voltage starter is used to start the motor, the following should be verified:
  - A. Correct quick trip, class 10 or better, ambient compensated overloads are incorporated.
  - B. Proper short circuit protection is utilized.
  - C. The torque required by the motor and pump package is attainable by this type starter.
  - D. The lead arrangement of the motor is acceptable with the proposed starter load connections.
  - E. Verify that if any time delay relays are used in switching contactors in and out, that the time settings do not exceed 2 seconds; this could damage the motor.
  - F. If a manual auto-transformer starter is used, voltage should be minimum 60% of rated voltage, and switched to "Run" condition within 2 seconds. Double check TABLE B and C for correct protection.
- 19) Single-Phase Motors (5-15HP)  
Proper connections and correct capacitors and relays are necessary for single-phase motor starting and running.  
Connection diagram: See Fig. 1.  
Performance and recommendable capacitors: See TABLE A.
- 20) VFD (Inverter)  
Please contact Hitachi for VFD (inverter) usage on Hitachi Submersible Motors.

## MAINTENANCE

There are no bearings that need oil or grease. The motor, being inaccessible, should be monitored through its electrical connections.

- 1) Measure and record operating current and voltage.
- 2) Measure and record the motor insulation resistance. Any resistance of less than 50 megohm for a new motor should be evaluated or checked further by a qualified service shop.
- 3) Lightning arrestors and/or surge capacitors will help prevent damage to the control box, cables, and motor.
- 4) Single-phase protection will help in preventing motor failure due to adverse incoming primary power.
- 5) Based on the values obtained in A and B above and the output flow rates and pressures of the pump, a complete picture of total performance can be obtained. This can be used to determine any pump and motor maintenance and overhauling which might be required.
- 6) If the motor is to be stored, protect the unit from freezing by storing in an area with a temperature higher than -30°C (-22°F).

## OPERATION

- 1) After energizing the motor, check the flow and pressure of the pump to make sure that the motor is rotating in the correct direction. To correct a wrong rotation, switch any two of the three cable connections. (Three-phase motor only)
- 2) When starting the pump for the first time, inspect the water for sand. If sand appears, then continue to pump till the water clears up; otherwise, sand will accumulate in the pump stages and will bind or freeze the moving parts if water is allowed to flow back down the well.
- 3) During testing or checking rotation (such as "bumping" or "inching") the number of "starts" should be limited to 3, followed by a full 15 minutes cooling-off period before any additional "starts" are attempted. Depending on the depth of the well and/or method of checking, these rotational checks or "starts" may actually be full-fledged starts. If this is the case, then a full cooling-off period of 15 minutes is required between this type of start.

- 4) For automatic (pilot device) operation, the motor should be allowed to cool for 15 minutes between stop and re-start.
- 5) Input voltage, current and insulation resistance values should be recorded throughout the life of the installation and should be used as a from of preventive maintenance.

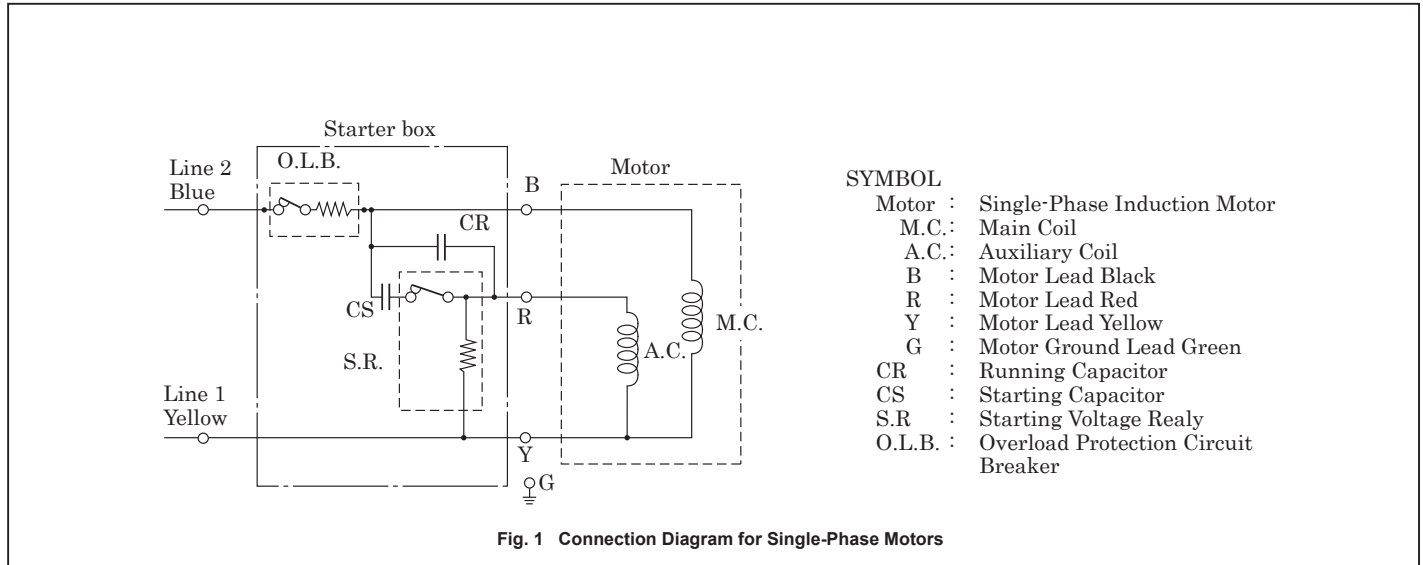

- SYMBOL**
- Motor : Single-Phase Induction Motor
  - M.C.: Main Coil
  - A.C.: Auxiliary Coil
  - B : Motor Lead Black
  - R : Motor Lead Red
  - Y : Motor Lead Yellow
  - G : Motor Ground Lead Green
  - CR : Running Capacitor
  - CS : Starting Capacitor
  - S.R. : Starting Voltage Relay
  - O.L.B. : Overload Protection Circuit Breaker

**TABLE A. PERFORMANCE DATA OF SINGLE-PHASE SUBMERSIBLE MOTOR**

2P FOR 6" DEEP WELL																																									
Output (HP)		5					7.5					10					15																								
Voltage-Frequency		230V 60Hz										230V 60Hz																													
No Load Current (A)		8.8										8.3										12.0										16.1									
No Load Loss (W)		1184										1428										1544										2050									
Load Characteristics	Load (%)	25	50	75	100	125	25	50	75	100	125	25	50	75	100	125	25	50	75	100	125																				
	Current (A)	11.5	14.6	18.9	23.8	30.2	13.6	19.5	26.7	35.2	45.6	18.0	25.5	35.5	48.0	59.0	25.5	38.1	52.7	70.8	96.8																				
	Efficiency (%)	47.8	66.2	72.2	74.8	72.8	51.1	67.6	72.5	72.9	70.8	54.0	67.8	73.1	73.6	71.5	57.5	70.8	74.7	73.7	69.2																				
	Power Factor (%)	73.5	84.0	89.0	91.2	92.3	87.8	92.5	94.5	94.9	94.2	81.8	88.9	91.8	93.2	93.7	82.9	90.2	92.7	93.2	90.8																				
	Slip (%)	0.8	1.5	2.2	3.0	4.2	0.8	1.8	2.9	4.2	5.8	0.7	1.7	2.8	4.1	5.6	1.0	2.1	3.3	4.9	7.3																				
Full Load Torque (ft•lbs)		7.53					11.42					15.23					23																								
Break Down Torque (ft•lbs)		15.5					22.0					27.4					45																								
Locked Rotor Torque (ft•lbs)		12.5					18.3					21.3					34																								
Locked Rotor Current (A)		124					167					202					275																								
Locked Rotor Code		G					F					E					D																								
Rated Input (W)		4987					7675					10135					15180																								
Current of SF 1.15 (A)		27.5					41					58					85																								
Input of SF 1.15 (W)		5735					8950					11830					18050																								
Spec.of Running Capacitor		440VAC 30µFD					440VAC 40µFD					440VAC 50µFD					440VAC 70µFD																								
Spec.of Starting Capacitor		330VAC 200µFD					330VAC 250µFD					370VAC 350µFD					370VAC 450µFD																								
Resistance (Ω)		R-Y	B-Y	R-B	R-Y	B-Y	R-B	R-Y	B-Y	R-B	R-Y	B-Y	R-B	R-Y	B-Y	R-B	R-Y	B-Y	R-B																						
		2.143	0.482	2.597	1.372	0.371	1.715	1.022	0.286	1.280	0.648	0.200	0.821																												

